

# Viatran DL Series

Dual-Line 6-Digit Analog Input Process Meter



PROCESS

- 0-20 mA, 4-20 mA, 0-5 V, 1-5 V, and  $\pm 10$  V Inputs
- NEMA 4X, IP65 Front
- Universal 85-265 VAC or 12/24 VDC Input Power
- Large Dual-Line 6-Digit Display, 0.60" & 0.46"
- Dual-Scale for Level Applications – Single Input
- Sunlight Readable Display Models
- Isolated 24 VDC @ 200 mA Transmitter Power Supply
- Signal Input Conditioning for Flow & Round Horizontal Tanks
- Programmable Displays & Function Keys
- 32-Point, Square Root, or Exponential Linearization
- Multi-Pump Alternation Control
- 2 or 4 Relays + Isolated 4-20 mA Output Options
- External 4-Relay & Digital I/O Expansion Modules
- USB, RS-232, & RS-485 Serial Communication Options
- Tare Function
- Modbus<sup>®</sup> RTU Communication Protocol Standard
- On-Board Digital Input
- Configure, Monitor, and Datalog from a PC with Free MeterView<sup>®</sup> Pro Software

38 Forge Parkway  
Franklin, MA USA 02038  
**Phone:** 1.716.629.3800  
**Fax:** 1.716.693.9162  
**Toll Free:** 1.800.688.0030  
**Email:** [solutions@viatran.com](mailto:solutions@viatran.com)  
**Website:** [www.viatran.com](http://www.viatran.com)



**VIATRAN**

# Viatran DL Series Dual-Line Analog Input Process Meter



UV Resistant  
Sunlight Readable Models



Front Panel  
NEMA 4X Rated

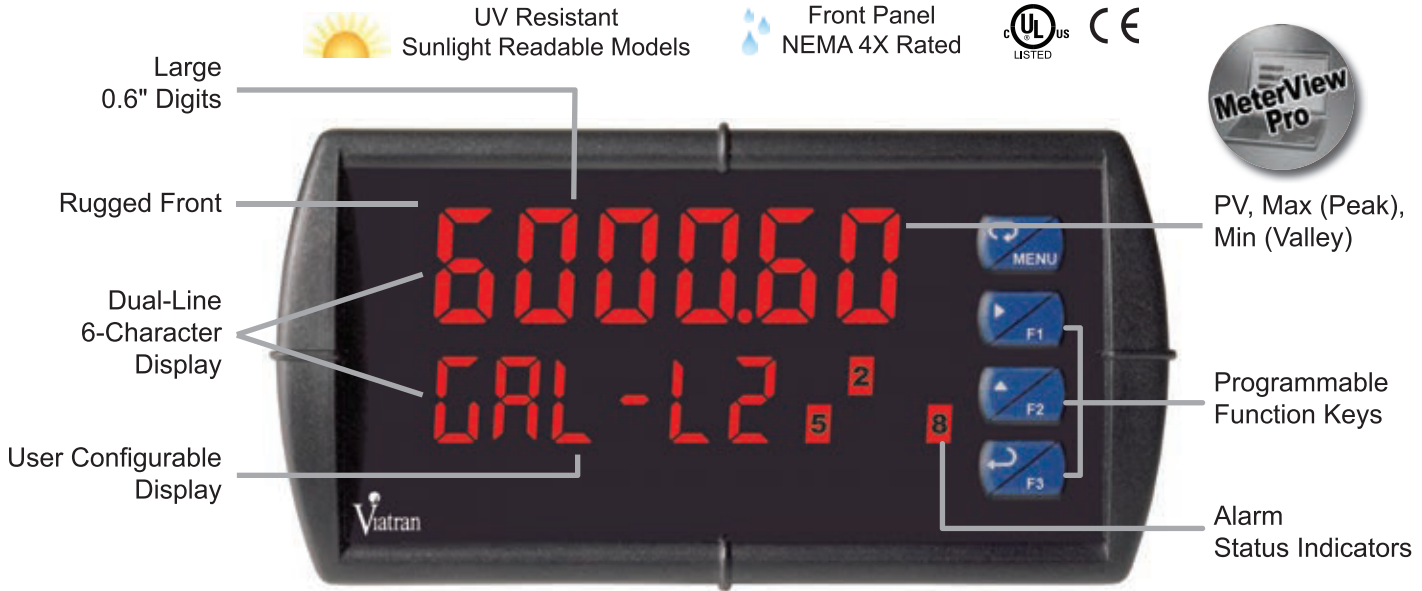

## FEATURE RICH AND FLEXIBLE

The Viatran DL meter boasts specifications and functionality that make it one of the most advanced process meters available. Its dual-line 6-digit display (999,999), advanced signal conditioning, function keys, Modbus RTU serial communications, and optional expansion modules are only a few of the features found on the Viatran DL series analog input meter.

## KEY FEATURES

### Precise, Accurate, and More Informative

The DL's large 0.6" upper display provides a highly accurate and precise 6-digit view of the process measurement. Its 24-bit A/D is accurate to  $\pm 0.03\%$  of calibrated span  $\pm 1$  count.

## Optional Sunlight Readable Display Models

The sunlight readable display models have an extraordinarily bright LED display. They are perfect for applications where the meter is in direct sunlight or in applications where visibility may be impaired by smoke, fog, dust, or distance. Option is available on all models.

## Function Keys

There are three function keys available to the user. These keys can be programmed to trigger certain events (i.e. acknowledge alarms, reset max and/or min, disable/enable output relays, or hold current relay states), provide direct menu access points, and more.



## Rugged

A unique front panel design makes the DL meter nearly impenetrable in typical applications. Here, the meter easily survives a direct hit on the display from a heavy 2" solid stainless steel ball dropped from eight feet.

## Easy to Use

The user friendly dual-line display makes the meter easy to set up & program. No jumpers to set for input selection. All setup & programming are done via the front panel. Three levels of password protection help maintain the reliability of the programming.



Flow in CFH



Gallons & Setpoint



Level in Feet



Pressure Indication

## Configurable

The upper display can be programmed to indicate PV, maximum (peak), minimum (valley), alternating maximum/minimum, one of eight alarm set points, or Modbus input. The lower display can also be configured to display engineering units, set points, user defined legends, or simply turned off.



Input Setup



Display Setup

## Dual-Scale Display Feature

The Viatran DL series meter has a rather unique, and very flexible dual-scale capability; a second scaled display can represent the measured input in a different form (i.e. gallons & height). This is of particular value in level applications. Please see the examples shown below. Both displays are independently scaled and are based on the 4-20 mA input signal. Beyond level, this function has been used for pressure & force, current & power, feet & meters, GPM & CFM, and more.



Gallons & mA



Gallons & Height



Gallons & Percent



Gallons & Head PSI

## Advanced Linearization Capability

The meter includes a 32-point linearizer. In non-linear level applications (i.e. some pumping or lift stations), it can easily compensate for submerged equipment or plumbing that displace usable volume. A second independent 8-point linearizer is available for a second scaled display (PV2) when "Level" function is enabled. Viatran's free MeterView Pro PC-based software greatly simplifies the construction of the linearization tables. The software can save this data to the meter and/or PC.

## On-Board Digital Input

The DL meter includes a digital input as standard. This digital input can operate with the tare, reset tare, or interlock relays feature, force relays on from a signal from a PLC or relay on other equipment, and much more. This is ideal for installations where the meter is inaccessible behind a cover, or where an additional function key is needed for customized operation.

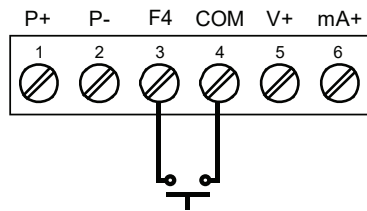

## Rounding

The rounding feature is used to give the user a steadier display with fluctuating signals. It causes the display to round to the nearest value according to the rounding value selected (1, 2, 5, 10, 20, 50, or 100). For example, with a rounding value of 10, and an input of 12346, the display would indicate 12350.

## Max/Min Display

Max/Min (or Peak/Valley) is standard on the DL meter. Either display can be configured to show either maximum or minimum excursion since last reset. The displays can also be configured to toggle between Max and Min values. Both values can be simply reset from the front panel.

## DIGITAL COMMUNICATIONS

### Modbus® RTU Serial Communications

With the purchase of a serial communication adapter, DL meters can communicate with any Modbus Master device using the ever-popular Modbus communications protocol. This greatly increases the flexibility of the meter. Modbus provides much more capability than read PV and write set points. Below are some examples of other things that can be done with Modbus communications.

- Send a 6-character message to the lower display upon an event
- Convert a digital value to a 4-20 mA signal
- Remote user control (i.e. change set points, acknowledge alarms)
- Input a Modbus digital PV (in place of analog input)
- Remote override of any, or all, relays and analog outputs



Modbus PV Input



Remote Message

# Viatran DL Series Dual-Line Analog Input Process Meter

## FIELD EXPANSION MODULES

Add functionality to the meter in the field with easy-to-install external expansion modules. Add USB, RS-232, or RS-485 communications, I/O modules (up to 2), and 4-relay expansion module. The menu items for these modules do not appear until the module is connected, simplifying the basic menu. Relay and digital I/O modules are shown below with optional DIN rail mounting kit, P/N 350PDA1002.



### 350PDA1044 I/O Expansion Module

Four digital inputs and four digital outputs are available per expansion module. The meter will accept two of these modules. External digital inputs can function similarly to the front panel function keys or on-board digital input F4. They can be configured to trigger certain events (i.e. acknowledge/reset alarms, reset max and/or min values, disable/enable all output relays, and hold current relay states), provide direct menu access point, or mimic front panel keys. The I/O module can be used to configure the meter remotely, in essence giving the user control of the four front panel push buttons. This feature is particularly useful if the meter is mounted inside an explosion-proof enclosure.

Digital outputs can be used to remotely monitor the meter's alarm relay output states, or the states of a variety of actions and functions executed by the meter.

### 350PDA1004 Relay Expansion Module

An external module containing four 3 A Form A (SPST) relays can be added to the meter at anytime. Removable screw terminal blocks accept 12 to 22 AWG wire.

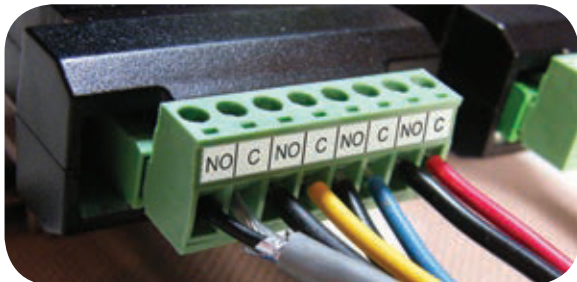

### 350PDA1232, 350PDA1485, & 350PDA8008 Communication Modules

Serial communications can be added anytime with external 350PDA1232 (RS-232), 350PDA1485 (RS-485), or 350PDA8008 (USB) communication adapters.

Free Modbus protocol comes standard with DL series meters.

## METERVIEW® PRO SOFTWARE

Configure, monitor, and datalog a DL series meter from a PC using MeterView Pro Software (available for download at [www.viatran.com](http://www.viatran.com)) and a serial adapter.

Monitor & Datalog

Linearization Utility

Setup

Relays

## OUTPUTS

### Relay Outputs

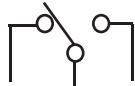

The DL meter has up to four 3 A Form C relays (SPDT) with multiple power loss fail-safe options. Relays can be configured for proper protective action upon input loop break. Relay ON and OFF delay times are user adjustable. Up to eight front panel indicators show alarm and/or relay state. All relays can be configured for 0-100% deadband.

### Relay Operation/Configuration

There are powerful relay functions that can be configured in the meter, including:

- Automatic reset only (non-latching)
- Automatic + manual reset at any time (non-latching)
- Latching (manual reset only)
- Latching with clear (manual reset only after alarm condition has cleared)
- Pump alternation control (automatic reset only)
- Sampling (activated for a user-specified time)
- User selectable fail-safe operation
- Relay action for loss (break) of 4-20 mA input signal
- Time delay (on and off), independent for each relay
- Manual control mode
- Interlock relay mode

### Analog Output

The isolated analog retransmission signal can be configured to represent the process variable (PV), maximum (peak) value, minimum (valley) value, the value for any of the eight relay set points, or Modbus input. While the output is nominally 4-20 mA, the signal will accurately accommodate under- and over-ranges from 1 to 23 mA.

### Manual Output Control

Take control of any output with this feature. All relays can be forced ON or OFF, and the 4-20 mA output signal can be set to any value within its range. When the relays and 4-20 mA output are controlled manually, an LED labeled "M" is turned on and the associated Alarm LEDs (1-8) flash every 10 seconds indicating that the meter is in manual control mode.



### Isolated Transmitter Power Supplies

A powerful 24 V @ 200 mA power supply is a standard feature on the meter. It can be configured for 5, 10, or 24 V (default) by means of a simple internal jumper (see manual). An additional power supply (24 V @ 40 mA) is standard with the 4-20 mA output option.

### Sampling Function (PV Triggered Timed Relay)

The sampling function allows the operator to set a set point for a "sampling" relay. When the PV reaches that set point, it will close that relay's contacts for a preset period of time (0.1 to 5999.9 seconds). An example of its use may be for beer/ale fermentation. When the batch reaches a certain pH, the relay contacts would close and by some means (light, horn, etc.) alert someone to take a sample, or provide the trigger to automatically take a sample of the batch. The utility of this function can, of course, be expanded beyond sampling and be used whenever a timed relay output closure is required when the PV reaches a certain set point.

### Interlock Relay(s)

This function allows a process to use one or more very low voltage input signals or simple switch contacts to control the state of one or more internal "interlock" relays. A violation (i.e. loss of input, open switch, or open circuit) forces one or more N/O interlock relay contacts to open. One input can be used in series with a number of interlock switches, or up to eight inputs can be required to force-one one (or more) internal interlock relays. Please see Application Note AN-1008 on our website for more information. Requires 350PDA1044 Digital I/O module or use of on-board digital input F4.

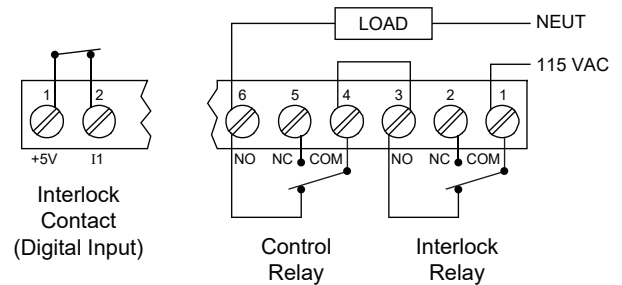

## SIGNAL INPUT CONDITIONING

Non-linear input signals (i.e. weirs & flumes, differential pressure, etc.) can be linearized with the meter's simple to use built-in signal input conditioners, such as: square-root extractor, exponential linearizer, horizontal round tank linearizer, or the meter's powerful general purpose 32-point linearizer.

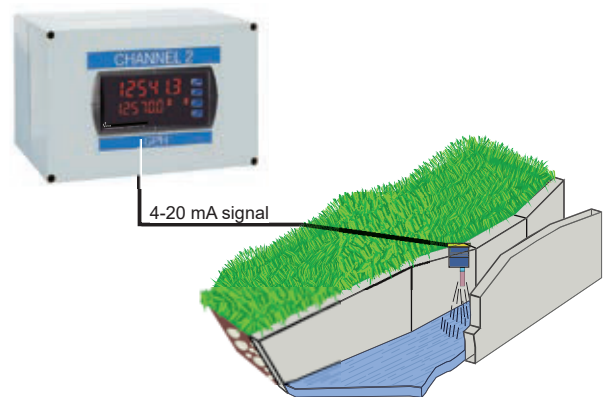

Flume Flow Calculated Using Exponential Signal Input Conditioner

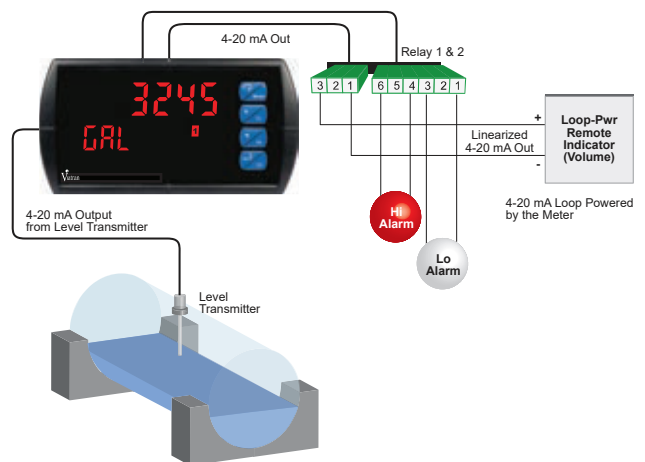

Round Horizontal Tank Signal Input Conditioner

# Viatran DL Series Dual-Line Analog Input Process Meter

## Multi-Pump Alternation

Up to 8 pumps can be alternated/sequenced.

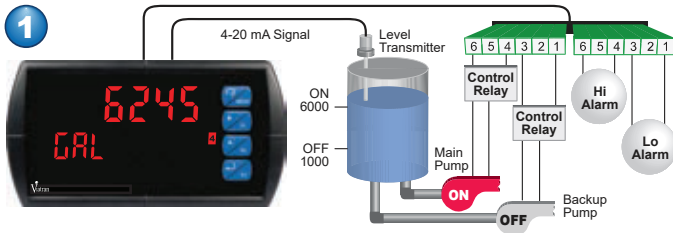

Relay #4 turns the main pump on at 6000 gallons and turns it off at 1000 gallons.

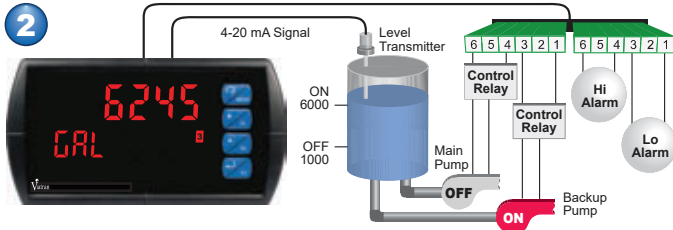

With the Pump Alternation feature activated, the next time the level reaches 6000 gallons, relay #3 transfers and starts the backup pump.

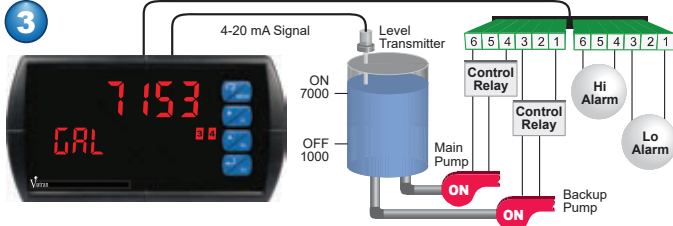

If the backup pump is not able to keep up, and the level reaches 7000 gallons, relay #4 transfers and starts the main pump as well.

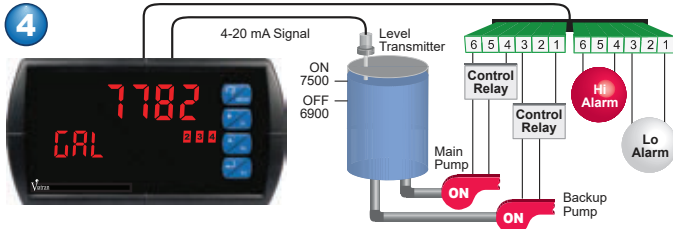

Relay #2 trips the High Level Alarm at 7500 gallons and resets at 6900 gallons.

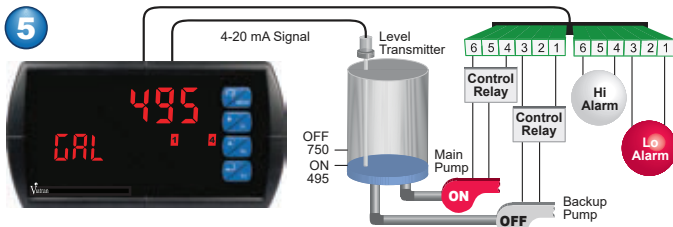

Relay #1 trips the Low Level Alarm at 495 gallons and resets at 750 gallons.

## NEMA 4 & 4X FIELD ENCLOSURES

Thermoplastic and stainless steel NEMA 4X, and painted steel NEMA 4 enclosures for DL series meters are available.



**350PDA2811**  
Plastic Low-Cost



**350PDA2812**  
Plastic Low-Cost

## CONNECTIONS

- Form C (SPDT) relays
- Two isolated supplies available even on 12/24 VDC input power models
- Removable terminal blocks
- 2 or 4 relays + isolated 4-20 mA output option

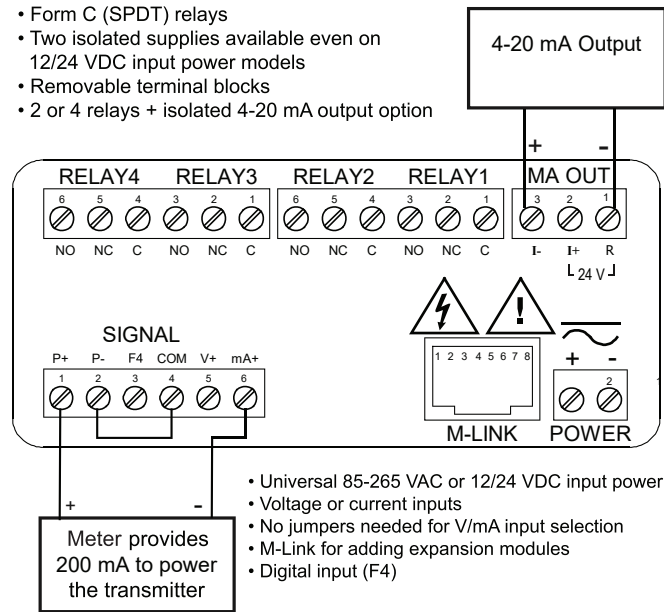

- Universal 85-265 VAC or 12/24 VDC input power
- Voltage or current inputs
- No jumpers needed for V/mA input selection
- M-Link for adding expansion modules
- Digital input (F4)

## SPECIFICATIONS

Except where noted all specifications apply to operation at +25°C.

### General

**Display:** Upper display: 0.60" (15 mm) high. Lower display: 0.46" (12 mm) high. Both are 6 digits (-99999 to 999999), red LEDs.

**Display Intensity:** Eight intensity levels

**Display Update Rate:** 5/second (200 ms)

**Overrange:** Display flashes 999999

**Underrange:** Display flashes -99999

**Display Assignment:** The upper and lower displays may be assigned to PV1, PV2, PCT (percent), d r-u, d gross, d nt-g, max/min, alternate max & min, set points, units (lower display only), or Modbus input.

**Front Panel:** NEMA 4X, IP65

**Programming Methods:** Four front panel buttons, digital inputs, PC and MeterView Pro software, Modbus registers, or cloning using Copy function.

**F4 Digital Input Contacts:** 3.3 VDC on contact. Connect normally open contacts across F4 to COM.

**F4 Digital Input Logic Levels:** Logic High: 3 to 5 VDC  
Logic Low: 0 to 1.25 VDC

**Noise filter:** Programmable from 2 to 199 (0 will disable filter)

**Filter Bypass:** Programmable from 0.1 to 99.9% of calibrated span

**Recalibration:** Calibrated at the factory. Recalibration is recommended at least every 12 months.

**Max/Min Display:** Max / min readings reached by the process are stored until reset by the user or until power to the meter is turned off.

**Password:** Three programmable passwords restrict modification of programmed settings.

**Non-Volatile Memory:** All programmed settings are stored in non-volatile memory for a minimum of ten years if power is lost.

**Power Options:** 85-265 VAC 50/60 Hz, 90-265 VDC, 20 W max, or jumper selectable 12/24 VDC  $\pm 10\%$ , 15 W max.

**Fuse:** Required external fuse: UL Recognized, 5 A max, slow blow; up to 6 meters may share one 5 A fuse.

**Isolated Transmitter Power Supply:** Terminals P+ & P-: 24 VDC  $\pm 10\%$ . 12/24 VDC powered models selectable for 24, 10, or 5 VDC supply (internal jumper J4).

85-265 VAC models rated @ 200 mA max, 12/24 VDC powered models rated @ 100 mA max, @ 50 mA max for 5 or 10 VDC supply.

**Normal Mode Rejection:** Greater than 60 dB at 50/60 Hz

**Isolation:** 4 kV input/output-to-power line. 500 V input-to-output or output-to-P+ supply.

**Overvoltage Category:** Installation Overvoltage Category II: Local level with smaller transient overvoltages than Installation Overvoltage Category III.

### Environmental:

Operating temperature range: -40 to 65°C

Storage temperature range: -40 to 85°C

Relative humidity: 0 to 90% non-condensing

**Connections:** Removable screw terminal blocks accept 12 to 22 AWG wire, RJ45 for external relays, digital I/O, and serial communication adapters.

**Enclosure:** 1/8 DIN, high impact plastic, UL 94V-0, color: black

**Mounting:** 1/8 DIN panel cutout required: 3.622" x 1.772"

(92 mm x 45 mm). Two panel mounting bracket assemblies are provided.

**Tightening Torque:** Screw terminal connectors: 5 lb-in (0.56 Nm)

**Dimensions:** 4.68" x 2.45" x 5.64" (119 mm x 62 mm x 143 mm) (W x H x D)

**Weight:** 9.5 oz (269 g)

**UL File Number:** UL & C-UL Listed. E160849; 508 Industrial Control Equipment.

**Warranty:** 3 years parts & labor

### Process Input

**Inputs:** Field selectable: 0-20, 4-20 mA,  $\pm 10$  VDC (0-5, 1-5, 0-10 V), Modbus PV (Slave)

**Accuracy:**  $\pm 0.03\%$  of calibrated span  $\pm 1$  count, square root & programmable exponent accuracy range: 10-100% of calibrated span

**Temperature Drift:** 0.005% of calibrated span/ $^{\circ}$ C max from 0 to 65 $^{\circ}$ C ambient, 0.01% of calibrated span/ $^{\circ}$ C max from -40 to 0 $^{\circ}$ C ambient

**Signal Input Conditioning:** Linear, square root, programmable exponent, or round horizontal tank volume calculation.

**Multi-Point Linearization:** 2 to 32 points for PV or PV1. 2 to 8 points for PV2 (Dual-Scale Level feature)

**Programmable Exponent:** 1.0001 to 2.9999

**Low-Flow Cutoff:** 0-999999 (0 disables cutoff function)

**Decimal Point:** Up to five decimal places or none: 0.00000, 00.0000, 000.000, 0000.00, 00000.0, or 000000.

**Calibration Range:** 4-20 mA: minimum span input 1 & input 2: 0.15 mA.  $\pm 10$  V: minimum span input 1 & 2: 0.10 V. An Error message will appear if input 1 and input 2 signals are too close together.

**Input Impedance:** Voltage ranges: greater than 1 M $\Omega$ . Current ranges: 50 - 100  $\Omega$  (depending on resettable fuse impedance).

**Input Overload:** Current input protected by resettable fuse, 30 VDC max. Fuse resets automatically after fault is removed.

### Relays

**Rating:** 2 or 4 SPDT (Form C) internal and/or 4 SPST (Form A) external; rated 3 A @ 30 VDC and 125/250 VAC resistive load; 1/14 HP ( $\approx 50$  watts) @ 125/250 VAC for inductive loads such as contactors, solenoids, etc.

**Noise Suppression:** Noise suppression is recommended for each relay contact switching inductive loads.

**Deadband:** 0-100% of span, user programmable

**High or Low Alarm:** User may program any alarm for high or low trip point. Unused alarm LEDs and relays may be disabled (turned off).

**Relay Operation:** automatic (non-latching), latching (requires manual acknowledge), sampling (based on time), pump alternation control (2 to 8 relays), Off (disable unused relays and enable interlock feature, manual on/off control mode).

**Relay Reset:** User selectable via front panel buttons or digital inputs.

1. Automatic reset only (non-latching), when input passes the reset point.
2. Automatic + manual reset at any time (non-latching).
3. Manual reset only, at any time (latching).
4. Manual reset only after alarm condition has cleared (latching).

*Note: Front panel button or digital input may be assigned to acknowledge relays programmed for manual reset.*

**Time Delay:** 0 to 999.9 seconds, on & off relay time delays. Programmable and independent for each relay.

**Fail-Safe Operation:** Programmable and independent for each relay.  
*Note: Relay coil is energized in non-alarm condition. In case of power failure, relay will go to alarm state.*

**Auto Initialization:** When power is applied to the meter, relays will reflect the state of the input to the meter.

### Serial Communications

**Protocol:** Modbus<sup>®</sup> RTU

**Meter Address/Slave ID:** 1 - 247

**Baud Rate:** 300 - 19,200 bps

**Transmit Time Delay:** Programmable between 0 and 199 ms or transmitter always on for RS-422 communication

**Data:** 8 bit (1 start bit, 1 or 2 stop bits)

**Parity:** Even, odd, or none with 1 or 2 stop bits

**Byte-to-Byte Timeout:** 0.01 - 2.54 seconds

**Turn Around Delay:** Less than 2 ms (fixed)

*Note: Refer to the Modbus Register Tables located at [www.viatran.com](http://www.viatran.com) for details.*

# Viatran DL Series Dual-Line Analog Input Process Meter

## Isolated 4-20 mA Transmitter Output

**Output Source:** Process variable (PV), max, min, set points 1-8, manual control setting, or Modbus input

**Scaling Range:** 1.000 to 23.000 mA for any display range

**Calibration:** Factory calibrated: 4.000 to 20.000 = 4-20 mA output

**Analog Output Programming:** 23.000 mA maximum for all parameters: Overrange, underrange, max, min, and break

**Accuracy:**  $\pm 0.1\%$  of span  $\pm 0.004$  mA

**Temperature Drift:**  $0.4 \mu\text{A}/^\circ\text{C}$  max from 0 to  $65^\circ\text{C}$  ambient,

$0.8 \mu\text{A}/^\circ\text{C}$  max from  $-40$  to  $0^\circ\text{C}$  ambient

*Note: Analog output drift is separate from input drift.*

**Isolated Transmitter Power Supply:** Terminals I+ & R: 24 VDC  $\pm 10\%$ . May be used to power the 4-20 mA output or other devices.

All models rated @ 40 mA max.

**External Loop Power Supply:** 35 VDC maximum

**Output Loop Resistance:**

Power supply	Minimum	Maximum
24 VDC	10 $\Omega$	700 $\Omega$
35 VDC (external)	100 $\Omega$	1200 $\Omega$

## Digital I/O Expansion Module

**Channels:** 4 digital inputs & 4 digital outputs per module

**System:** Up to 2 modules for a total of 8 inputs & 8 outputs

**Digital Input Logic: High:** 3 to 5 VDC **Low:** 0 to 1.25 VDC

**Digital Output Logic: High:** 3.1 to 3.3 VDC **Low:** 0 to 0.4 VDC

**Source Current:** 10 mA maximum

**Sink Current:** 1.5 mA minimum

**+5 V Terminal:** To be used as pull-up for digital inputs only.

## 4-Relay Expansion Module

**Relays:** Four Form A (SPST) rated 3 A @ 30 VDC and 125/250 VAC resistive load; 1/14 HP ( $\approx 50$  watts) @ 125/250 VAC for inductive loads.

## DIMENSIONS

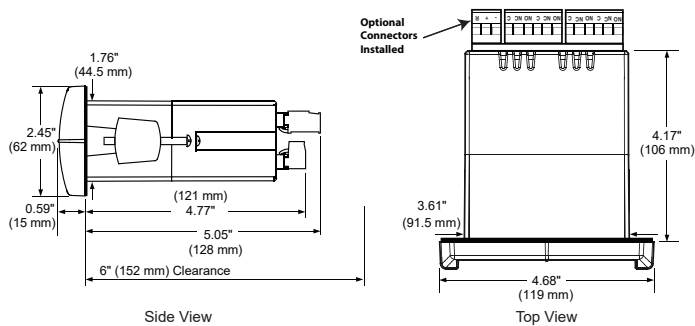

Notes:

1. Panel cutout required: 1.772" x 3.622" (45 mm x 92 mm)
2. Panel thickness: 0.040 - 0.250" (1.0 mm - 6.4 mm)
3. Mounting brackets lock in place for easy mounting
4. Clearance: Allow 6" (152 mm) behind the panel

## Disclaimer

The information contained in this document is subject to change without notice. Viatran Corporation makes no representations or warranties with respect to the contents hereof, and specifically disclaims any implied warranties of merchantability or fitness for a particular purpose.

©2016 Viatran Corporation. All rights reserved.

## ORDERING INFORMATION

DL Series • Standard Models		
85-265 VAC Model	12/24 VDC Model	Options Installed
DL-ACS0N	DL-DCS0N	None
DL-ACS2N	DL-DCS2N	2 Relays
DL-ACS0R	DL-DCS0R	4-20 mA Output
DL-ACS4N	DL-DCS4N	4 Relays
DL-ACS2R	DL-DCS2R	2 Relays & 4-20 mA Output
DL-ACS4R	DL-DCS4R	4 Relays & 4-20 mA Output

Note: 24 V Transmitter power supply standard on all models.

DL Series • Sunlight Readable Display Models		
85-265 VAC Model	12/24 VDC Model	Options Installed
DL-ACB0N	DL-DCB0N	None
DL-ACB2N	DL-DCB2N	2 Relays
DL-ACB0R	DL-DCB0R	4-20 mA Output
DL-ACB4N	DL-DCB4N	4 Relays
DL-ACB2R	DL-DCB2R	2 Relays & 4-20 mA Output
DL-ACB4R	DL-DCB4R	4 Relays & 4-20 mA Output

Note: 24 V Transmitter power supply standard on all models.

Accessories	
Model	Description
350PDA1002	DIN Rail Mounting Kit for Two Expansion Modules
350PDA1004	4-Relay Expansion Module
350PDA1044	4 Digital Inputs & 4 Digital Outputs Module
350PDA1232	RS-232 Serial Adapter
350PDA1485	RS-485 Serial Adapter
350PDA7485-I	RS-232 to RS-422/485 Isolated Converter
350PDA7485-N	RS-232 to RS-422/485 Non-Isolated Converter
350PDA8008	USB Serial Adapter
350PDA8232-N	USB to RS-232 Non-Isolated Converter
350PDA8485-I	USB to RS-422/485 Isolated Converter
350PDA8485-N	USB to RS-422/485 Non-Isolated Converter
350PDX6901	Suppressor (snubber): 0.01 $\mu\text{F}/470 \Omega$ , 250 VAC

Your Local Representative is:



38 Forge Parkway | Franklin, MA USA 02038  
 Phone: 1.716.629.3800 | Fax: 1.716.693.9162 | Toll Free: 1.800.688.0030  
 Email: solutions@viatran.com | Website: www.viatran.com

98DSL\_B  
 LDS6000VC\_AX01  
 03/16