



VIATRAN



INSTALLATION DATA MANUAL

MODEL 385

Flush Tip Pressure Transmitter

38 Forge Parkway
Franklin, MA 02038
Int'l: 1-716-629-3800
Toll Free: 1-800-688-0030
Fax: 1-716-693-9162
www.viatran.com
solutions@viatran.com

PRODUCT OVERVIEW

All information contained in this document is representative of a standard Model 385. If the product you ordered has special requirements or modifications, refer to the permanently marked information on the product and your purchase order for possible alteration to the product's configuration. Failure to verify product configuration before installation may cause permanent product damage and in most cases, void the manufacturer's product warranty. If you are unsure or have questions about your product, please contact application engineering at 800-688-0030 for assistance. Remove and retain all instruction manuals and performance certificates that are shipped with the product. These documents provide important information on the product's calibration, operation, safety precautions, recommended maintenance, recalibration requirements, repair service instructions and warranty information. These documents are updated from time to time as changes to the product occur and should be reviewed at receipt so that proper and safe installation can occur.

GENERAL REQUIREMENTS & CAUTIONS

1. All electrical & pressure connections should be compatible with the model specifications as outlined below.
2. Installation should occur only after electrical (input power) and line pressure is verified as being off and at zero.
3. The product's internal electrical circuitry is isolated from case ground. It is not recommended that the case or ground of the unit be connected to the input, output or calibrate pins of the product or wiring system. Ground loops and line noise will affect the product's performance and will in most cases cause internal electrical failure.
4. All products should be protected from direct or continued exposure to fluids at the electrical connection. It is recommended that for products installed in areas where the potential for contamination at the electrical connection is possible a "boot" or other protective measure be taken to eliminate possible deterioration of the product's electrical connection and corrosion that will impede product performance.
5. This product is available with an optional breather opening, with a breather plug which is used to allow for proper product function. At no time should any mist, vapor or fluid be permitted to enter this breather as unit failure may occur. (A protective cover may be required.)
6. At no time should an object be inserted into the pressure port or pressed against the sensing area to deflect the sensor (to test or simulate pressure), as permanent damage to the sensing diaphragm may occur.
7. When shipped in quantities, units should be packaged individually to prevent possible damage.

ACCESSORIES - OPTIONAL EQUIPMENT

Please contact Viatran for these and other available accessories.

Mating Connectors

Digital Indicators

ELECTRICAL CONNECTIONS

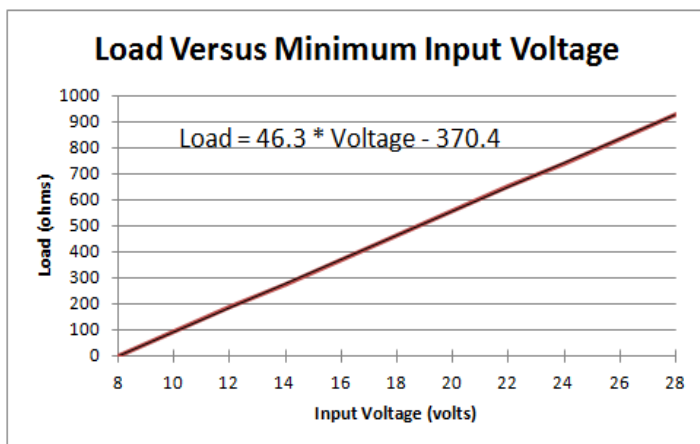

The standard wiring of your Viatran pressure transmitter is outlined on page 3. If your unit was ordered with an alternate connector or special wiring refer to the wiring information permanently marked on your unit. The 385 transmitter can be powered by a DC power supply ranging from 8 to 28 volts. With a 4-20 mA device please refer to the load/voltage chart (right) to identify the required input voltage for your specific system load.

INSTALLATION DATA – VIATRAN MODEL 385

Note: The drawing below is for informational purposes only and is not to scale.
All dimensions are nominal, in inches and for reference purposes only.

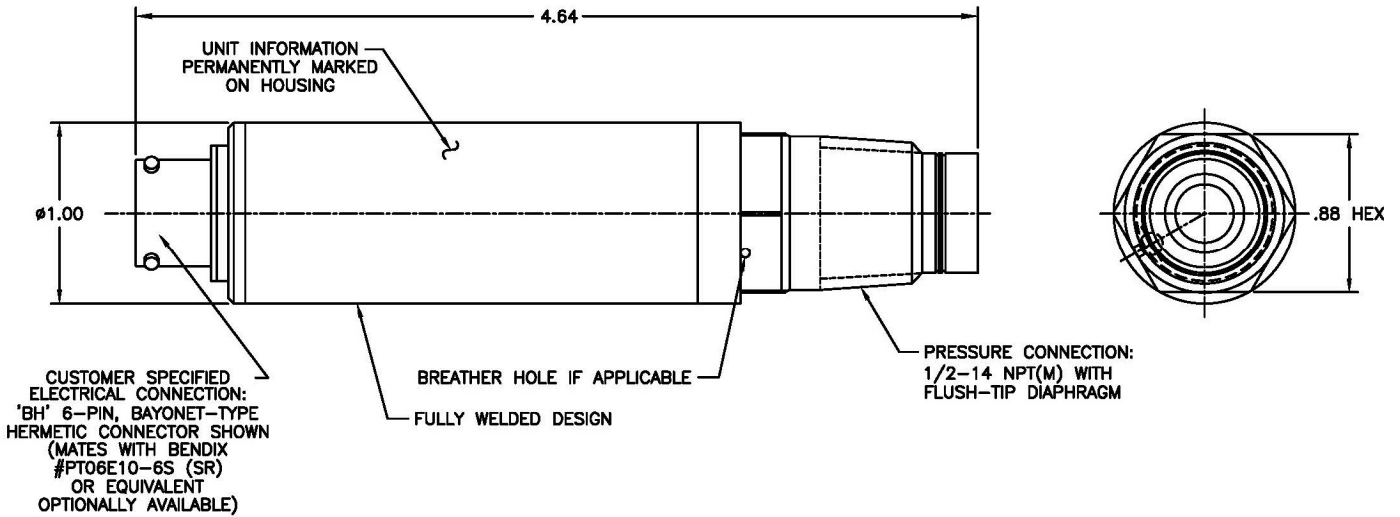

CONNECTION DIAGRAMS & WIRING

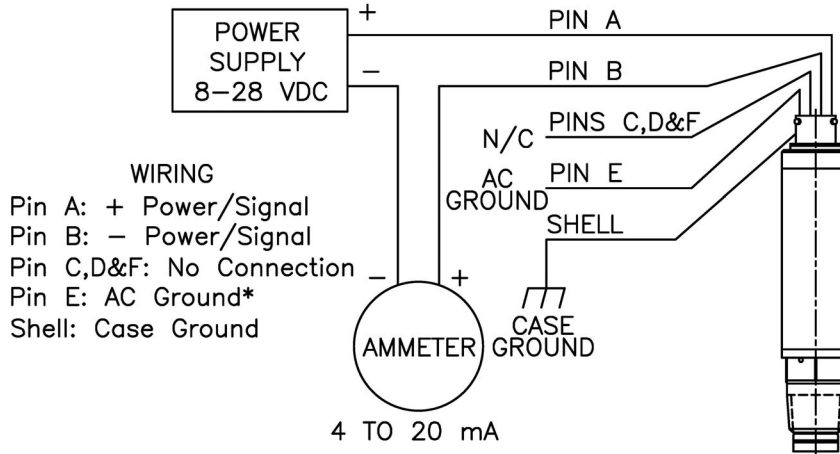

Wetted Material:	15-5 PH and 304L stainless steel
Sensor construction:	Bonded foil strain gage
Pressure connection:	Flush Diaphragm
Model output:	4-20 mA
Electrical mating connector:	Customer specified, BH option shown
Pressure connection:	½" npt (M)

***Note:** An AC case ground connects the ground pin to the housing through a capacitor. This filters noise while blocking DC signals. A DC case ground, which is a direct connection to the housing, or no case ground, are optional.

If your unit is equipped with a ½ NPT (M) pressure port, the unit may be installed using Teflon® tape or suitable liquid thread sealant (preferred). As a general guideline, after hand – tight engagement, tighten 2-3 full turns with a wrench until the fit feels right. If a torque wrench is used, 25 to 30 ft lbs should achieve a good seal with minimal zero shift.

MAINTENANCE AND REPAIR

All Viatran transmitters have been designed to function free from routine or scheduled maintenance. Simple cleaning of the electrical connector, sensing diaphragm and pressure port threads on an as needed basis will provide many years of satisfactory performance. Protecting the product from continued exposure to moisture or fluids at the electrical connection and breather area will eliminate premature internal failure of the product. Generally any time the product is removed from service, the sensing diaphragm should be cleaned with a stainless steel compatible cleaner to prevent media buildup. During the cleaning process only a soft, lint-free cloth is recommended. Never use a coarse or stiff bristle brush to clean media from the diaphragm surface.

It is suggested that the calibration be verified on a usage dependent schedule. If the product is in continuous service 7 days a week, then calibration verification may be necessary every 6 to 8 months. If the product is in a lab test environment, a more lenient verification schedule would be appropriate. In all instances the performance of the product will depend on the individual application or process in which it is installed. More continued usage would require a shorter period between calibration verification and product maintenance.

If a product is perceived to be exhibiting problems, it can be returned to Viatran for analysis and/or repair. It is suggested that only Viatran personnel attempt repair of the product. Any damage resulting from customer disassembly would result in a loss of coverage under the warranty policy. Older products returned for repair are updated to current specifications unless the repair cost would outweigh the cost of a new replacement model. Products returned for repair should include information on the person to contact for repair quote approval, the individual to contact if Viatran's technical staff requires additional information during analysis, and a brief description of the problem associated with the product's failure.

REPAIR INSTRUCTIONS

Viatran's Transmitters are designed to be easily repaired and recalibrated if necessary. If a failure occurs, the transmitter should be returned to the factory for inspection and testing. Please contact the Customer Support Department at 1-800-688-0030 for a return tracking number and/or a repair cost estimate. A nominal inspection fee is charged on all units returned to the factory which are not subsequently repaired.

WARRANTY

Viatran Corporation warrants that its products shall be free from defective workmanship and/or material for a period of twelve (12) months from the date of shipment, provided that Viatran's obligation hereunder shall be limited to correcting any defective workmanship and/or replacing any defective material f.o.b. factory. No allowance will be made for any expense incurred for correcting any defective workmanship and/or material without written consent by Viatran. This warranty is in lieu of all other warranties expressed or implied.

**38 Forge Parkway
Franklin, MA 02038
Int'l: 1-716-629-3800
Toll Free: 1-800-688-0030
Fax: 1-716-693-9162
www.viatran.com
solutions@viatran.com**