



**INSTALLATION DATA MANUAL
MODEL 550
PRESSURE TRANSMITTER**

**38 Forge Parkway
Franklin, MA 02038
Int'l: 1-716-629-3800
Toll Free: 1-800-688-0030
Fax: 1-716-693-9162
www.viatran.com**

solutions@viatran.com

COMPANY BACKGROUND

Viatran is an ISO 9001:2008 certified company committed to providing high quality pressure transducers and transmitters. Established more than 40 years ago, Viatran has built its reputation on providing durable, and accurate pressure sensing devices. Our products are often specifically specified by integrators and engineering firms for applications ranging from the offshore oil rigs to pump control to tank and well level measurement. Viatran is often called on for custom modifications for applications where standard products are not available.

TECHNICAL SUPPORT

Technical assistance is available Monday-Friday 8:00 AM to 5:00 PM (Eastern) from our knowledgeable factory personnel to answer any of your application or installation questions. Our toll free number is 1-800-688-0030. Questions or additional documentation can also be requested via e-mail at solutions@viatran.com.

CUSTOMER SERVICE

Orders for additional units or accessories can be placed by calling customer service at 1-800-688-0030 or by fax at 716-693-9162. Orders can also be placed by contacting a local representative in your area. To find the nearest representative visit our web site at www.viatran.com and click on rep search.

PRODUCT OVERVIEW

MANUAL SCOPE: Information contained in this document is representative of a standard Model 550. If the product has special requirements or modifications, refer to the permanently marked information on the product and your purchase order for possible alteration to the product's configuration. Failure to verify product configuration before installation may cause permanent product damage and in most cases, void the manufacturer's product warranty. If you are unsure or have questions about your product, please contact your Application Engineer 1-800-688-0030 for assistance.

Remove and retain all enclosed instruction manuals and performance certificates. These documents provide important information on the product's calibration, operation, safety precautions, recommended maintenance, re-calibration requirements, repair service instructions and warranty information. These documents are updated from time to time as changes to the product occur and should be reviewed at receipt so that proper and safe installation can occur.

PRODUCT DESCRIPTION AND GENERAL USE: Viatran's model 550 uses a 17-4 pH stainless steel strain gage diaphragm sensor (Inconel X750 optional). The 550 is designed to measure process pressures in applications compatible with 17-4 pH stainless steel. The 550 has a standard output of 4-20 mA. The standard electrical connection are 3' pigtail leads potted in a ½" NPT male conduit connection which can be easily connected inside a conduit connection box. Model 550 is approved by FM as non-incendive and intrinsically safe. Viatran provides many standard options including alternate connectors to custom fit your unit. The 550 is specially designed for the pulp and paper industry.

BASIC OPERATION

The model 550 is pre-set at the factory for the required output and is referenced to local atmospheric pressure for sealed gage units. Once factory set, the product should perform as indicated by the performance certificate and product labeling. Any deviation from the factory settings could indicate damage to the sensor, electronics or both. All units are sent with a calibration card that contains the unique calibration for your Viatran unit. Please retain this sheet; should the zero or span reading vary greatly from the calibration card it may indicate damage to the sensor.

HANDLING REQUIREMENTS AND CAUTIONS

1. All electrical & pressure connections should be compatible with the model specifications as outlined.
2. The product's internal electrical circuitry is DC isolated from case ground. It is recommended that the case ground wire be connected to earth ground at the cable termination, as this is an integral part of the internal surge protection and noise immunity features.
3. At no time should an object be pressed against the sensing area to deflect the sensor (to test or simulate pressure), as on some models permanent damage to the sensing diaphragm may occur.
4. When shipped in quantities, units should be packaged individually to eliminate possible damage.

INSTALLATION DATA - VIATRAN MODEL 550

Note: The drawing below is for informational purposes only and is not to scale.
All dimensions are nominal, in inches and for reference purposes only.

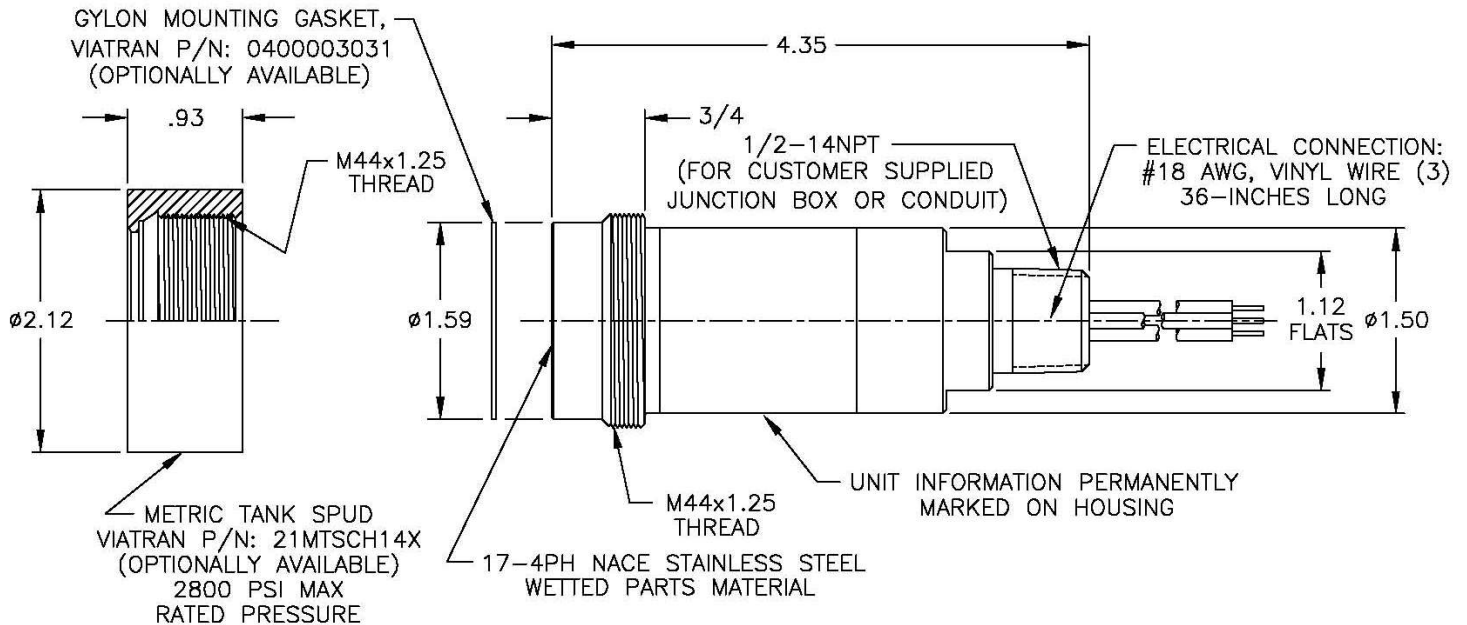

CONNECTION DIAGRAMS & WIRING

Sensor Construction and Wetted Materials:
17-4 Stainless Steel
(Inconel X750 optional)

Pressure Connection:
M44 X 1.25 thread, flush diaphragm

Electrical Mating Connection:
Acceptable 18AWG wire termination connection
1/2" NPT (M)

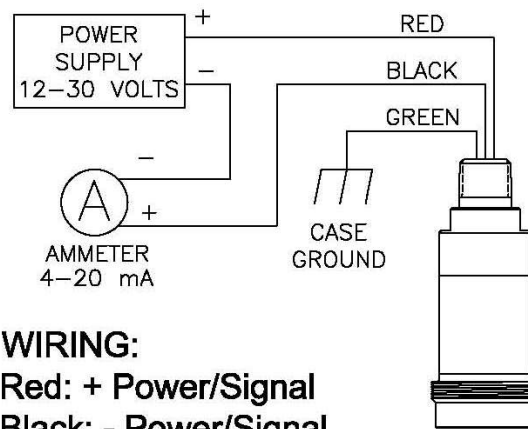

WIRING:
Red: + Power/Signal
Black: - Power/Signal
Green: Case Ground

Note: If the unit is certified for hazardous locations as Intrinsically Safe, use the enclosed connection diagram. Only the pressure transmitter is considered to have the Factory Mutual safety ratings. If you have purchased a transmitter and isolator/remote seal, they have not been tested as a system for safety certification. The end-user shall be responsible for verifying the system is safe and installed accordingly.

MECHANICAL INSTALLATION

The model 550 is mounted in a M44 X 1.25 threaded process connection. The unit may be mounted directly to the process fitting in any orientation with negligible positioning error. To mount the unit, thread the pressure fitting into the proper tank spud. The unit must be tight in the spud with the diaphragm flush with the gasket. Tighten until the unit and gasket form a seal.

ELECTRICAL CONNECTIONS

The standard wiring of your Viatran pressure transmitter is outlined on page 3. If your unit was ordered with an alternate connector or special wiring, refer to the wiring information permanently marked on your unit. The 550 transmitter can be powered by a DC power supply ranging from 12 to 30 volts. With a 4-20 mA device please refer to the load/voltage chart (below) to identify the required input voltage for your specific system load.

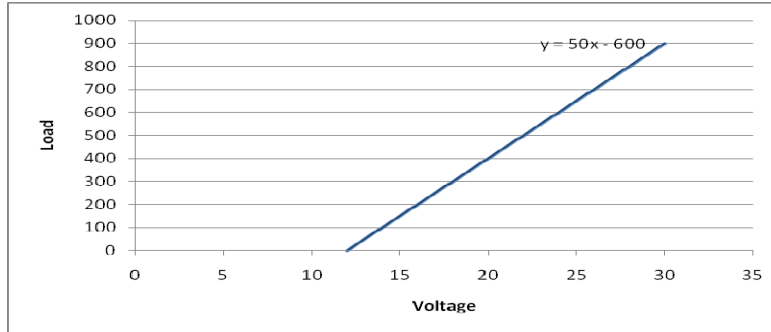

MAINTENANCE AND REPAIR

All Viatran transmitters have been designed to function free from routine or scheduled maintenance. Simple cleaning of the pressure sensor on an as needed basis will provide many years of satisfactory performance. Protecting the product from continued exposure to moisture or fluids at the electrical connection will eliminate premature internal failure of the product. Generally any time the product is removed from service, the pressure sensor should be flushed with a stainless steel compatible cleaner to prevent media buildup. During the cleaning process only a soft, lint-free cloth is recommended. Never use a coarse or stiff bristle brush to clean media from the diaphragm surface.

It is suggested that the calibration be verified on a usage dependent schedule. If the product is in continuous service 7 days a week, then calibration verification may be necessary every 6 to 8 months. If the product is in a lab test environment, a more lenient verification schedule would be appropriate. In all instances the performance of the product will depend on the individual application or process in which it is installed. More continuous usage would require a shorter period between calibration verification and product maintenance.

If a product is perceived to be exhibiting problems, it can be returned to Viatran for analysis and/or repair. It is suggested that only Viatran personnel attempt repair of the product. Any damage resulting from customer disassembly would result in a loss of coverage under the warranty policy. Older products returned for repair are updated to current specifications unless the repair cost would outweigh the cost of a new replacement model. Products returned for repair should include information on the person to contact for repair quote approval, the individual to contact if Viatran's technical staff requires additional information during analysis, and a brief description of the problem associated with the product's failure.

REPAIR INSTRUCTIONS

Viatran's Transmitters are designed to be easily repaired and recalibrated if necessary. If a failure occurs, the transmitter should be returned to the factory for inspection and testing. Please contact the Customer Support Department at 1-800-688-0030, for a return authorization number and/or a repair cost estimate. A nominal inspection fee is charged on all units returned to the factory which are not subsequently repaired.

WARRANTY

Viatran Corporation warrants that its products shall be free from defective workmanship and/or material for a period of twelve (12) months from the date of shipment, provided that Viatran's obligation hereunder shall be limited to correcting any defective workmanship and/or replacing any defective material f.o.b. factory. No allowance will be made for any expense incurred for correcting any defective workmanship and/or material without written consent by Viatran. This warranty is in lieu of all other warranties expressed or implied.

OPTIONAL CERTIFICATIONS

550_TF_(A)
[All product ≥300 PSIS]

APPROVED

INTRINSICALLY SAFE FOR USE IN
CLASS I,II,III, DIV. 1, GROUPS A,B,C,D,E,F,G
CLASS I, ZONE 0, AEx ia IIC T4, Ta=80°C,
T5, Ta=40°C NEMA/TYPE 4X, HAZ. LOC.
INSTALL PER CD0667
DUAL SEAL for Process Temps -40°F to 300°F

550_TF_(B)
[All product ≤299 PSIS]

APPROVED

INTRINSICALLY SAFE FOR USE IN
CLASS I,II,III, DIV. 1, GROUPS A,B,C,D,E,F,G
CLASS I, ZONE 0, AEx ia IIC T4, Ta=80°C,
T5, Ta=40°C NEMA/TYPE 4X, HAZ. LOC.
INSTALL PER CD0667

550_TF_(C)
[All alternate electrical connections]

APPROVED

INTRINSICALLY SAFE FOR USE IN
CLASS I, DIV. 1, GROUPS A,B,C,D,
CLASS I, ZONE 0, AEx ia IIC T4, Ta=80°C,
T5, Ta=40°C HAZARDOUS LOCATIONS
INSTALL PER CD0667

550_NK_(A)
[WITH WIRE]

Ex ia IIC T4 Ga
(-20°C < Ta < 40°C)
Ui=28V, li=100mA, Pi<1W
Ci=6,0nF, Li=1,2uH
LCIE 03 ATEX 6373 X

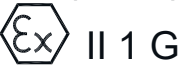

550_NK_(B)
[WITH CABLE]

Ex ia IIC T4 Ga
(-20°C < Ta < 40°C)
Ui=28V, li=100mA, Pi<1W
Ci=0,1uF, Li=0,1mH
LCIE 03 ATEX 6373 X



550_NZ_(A)
[All product ≥300 PSIS]

APPROVED

NONINCENDIVE FOR USE IN
CLASS I, II & III, DIV. 2,
GRPS A,B,C,D,F,G
CL I, ZN 2, GRP IIC
T4, Ta=80°C, T5, Ta=40°C
NEMA/TYPE 4X, HAZ LOC
DUAL SEAL
for Process Temps -40°F to 300°F

550_NZ_(B)
[All product ≤299 PSIS]

APPROVED

NONINCENDIVE FOR USE IN
CLASS I, II & III, DIV. 2,
GRPS A,B,C,D,F,G
CL I, ZN 2, GRP IIC
T4, Ta=80°C, T5, Ta=40°C
NEMA/TYPE 4X, HAZ LOC

550_NZ_(C)
[ZU option only]

APPROVED

NONINCENDIVE FOR USE IN
CLASS I, DIV. 2, GRPS A,B,C,D
CL I, ZN 2, GRP IIC
T4, Ta=80°C, T5, Ta=40°C HAZ LOC

550_TW_



TC RU C-US.BH02.B.00653/18
0Ex ia IIC Ga
T4: -20°C < Ta < 80°C
T5: -20°C < Ta < 40°C
METROLOGY CERT:
OC.C.30C001.A No 73774

SPECIAL CONDITIONS FOR USE

| Certificate | Type | Special Instruction |
|------------------------|-------------------------|---|
| LCIE 03 ATEX 6373 X-03 | ATEX Intrinsically Safe | The equipment must only be connected to certified intrinsically safe equipment. This combination must be compatible as regards intrinsic safety use |

38 Forge Parkway
Franklin, MA 02038
Toll Free: 1-800-688-0030
International: 716-629-3800
Fax: 716-693-9162
www.viatran.com
solutions@viatran.com