



**INSTALLATION DATA MANUAL
MODELS 548/748/848
PRESSURE TRANSMITTERS**

**199 Fire Tower Drive
Tonawanda, NY 14150
Int'l: 1-716-629-3800
Toll Free: 1-800-688-0030
Fax: 1-716-693-9162
www.viatran.com
solutions@viatran.com**

COMPANY BACKGROUND

Viatran is an ISO 9001:2000 certified company committed to providing high quality pressure transducers and transmitters. Established more than 40 years ago, Viatran has built its reputation on providing durable, and accurate pressure sensing devices. Our products are often specifically requested by integrators and engineering firms for applications ranging from the offshore oil rigs to pump control to tank and well level measurement. Viatran is often called for custom modifications for applications where standard products are not available.

TECHNICAL SUPPORT

Technical assistance is available Monday-Friday 8:00 AM to 5:00 PM (Eastern) from our knowledgeable factory personnel to answer any of your application or installation questions. Our toll free number is 1-800-688-0030. Questions or additional documentation can also be requested via e-mail at solutions@viatran.com.

CUSTOMER SERVICE

Orders for additional units or accessories can be placed by calling customer service at 1-800-688-0030 or by fax at 716-693-9162. Orders can also be placed by contacting a local representative in your area. To find the nearest representative visit our web site at www.viatran.com and click on rep search.

PRODUCT OVERVIEW

MANUAL SCOPE: Information contained in this document is representative of a standard Model 548/748/848. If the product has special requirements or modifications, refer to the permanently marked information on the product and your purchase order for possible alteration to the product's configuration. Failure to verify product configuration before installation may cause permanent product damage and in most cases, void the manufacturer's product warranty. If you are unsure or have questions about your product, please contact your Application Engineer (1-800-688-0030) for assistance.

Remove and retain all enclosed instruction manuals and performance certificates. These documents provide important information on the product's calibration, operation, safety precautions, recommended maintenance, re-calibration requirements, repair service instructions and warranty information. These documents are updated from time to time as changes to the product occur and should be reviewed at receipt so that proper and safe installation can occur.

PRODUCT DESCRIPTION AND GENERAL USE: Viatran's model X48 uses a piezoresistive sensing chip mounted behind an isolated diaphragm constructed of stainless steel. The 48 series is designed to measure process pressures in applications compatible with stainless steel. The 548, 748 and 848 have standard outputs of 4-20 mA, 0-5 V dc or mV/V respectively. The standard electrical connections are 6' pigtail leads potted in a 1/2" NPT male conduit connection which can be easily connected inside a conduit connection box. Model 548, 748 and 848 are approved for use in hazardous locations by FM, CSA and ATEX for explosion proof, non-incendive and intrinsically safe. Viatran provides many standard options including alternate pressure port fittings and connectors to custom fit your unit. The 548 and 748 also offers an improved linearity option to improve the accuracy of the unit to better than 0.1% FSO best fit straight line.

BASIC OPERATION

The model X48 is pre-set at the factory for the required output and is referenced to atmospheric pressure (zero PSIG), with the exception of absolute units. The reference for an absolute unit is absolute zero (full vacuum). Once factory set, the product should perform as indicated by the performance certificate and product labeling. Any deviation from the factory settings could indicate damage to the sensor, electronics or both. If your product is equipped with zero and span adjustments the unit can be recalibrated if a calibrated pressure source is available, or by using the shunt cal if your unit is equipped with this option. All units are sent with a calibration card that contains the unique calibration for your Viatran unit. Please retain this sheet; should the zero or span reading vary greatly from the calibration card it may indicate damage to the sensor or some form of obstruction in the breather filter, if equipped.

HANDLING REQUIREMENTS AND CAUTIONS

1. All electrical & pressure connections should be compatible with the model specifications as outlined above.
2. The product's internal electrical circuitry is DC isolated from case ground. It is recommended that the case ground wire be connected to earth ground at the cable termination, as this is an integral part of the internal surge protection and noise immunity features.
3. On some lower range models a breather opening, with breather filter, is used to allow for proper product function. At no time should the filter be removed in service. If any mist, vapor or fluid is permitted to enter this breather without the filter, unit failure may occur.
4. At no time should an object be pressed against the sensing area to deflect the sensor (to test or simulate pressure), as on some models permanent damage to the sensing diaphragm may occur.
5. When shipped in quantities, units should be packaged individually to eliminate possible damage.

INSTALLATION DATA - VIATRAN MODEL 548/748/848

Note: The drawing below is for informational purposes only and is not to scale.
All dimensions are nominal, in inches and for reference purposes only.

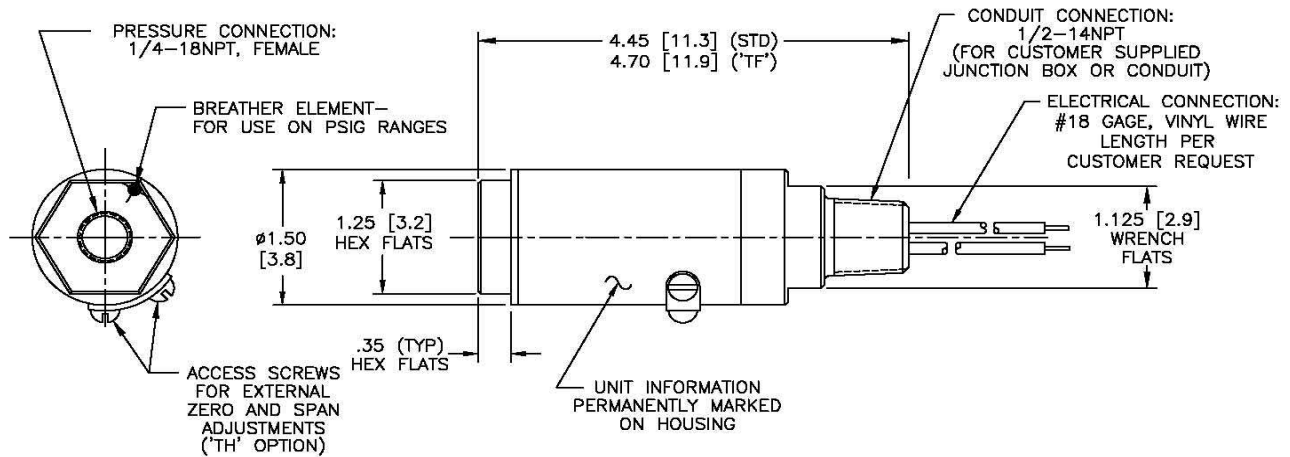

MODEL 548

Input:
9 - 30 VDC
9 - 28 VDC approved units
Output:
4 - 20 mA

MODEL 748

Input:
9 - 30 VDC
9 - 28 VDC approved units
Output:
0 - 5 VDC

MODEL 848

Input:
10 V nominal, 15 V Maximum
Output:
5 - 10 mV/V

Sensor Construction and Wetted materials

0 - 3 thru 0 - 5000 PSI: Oil Filled - Silicon - 316 Stainless Steel

Pressure Connection

1/4" NPT female

CONNECTION DIAGRAMS & WIRING

Electrical Mating Connection:

Acceptable 18AWG wire termination connection - 1/2" NPT (M)

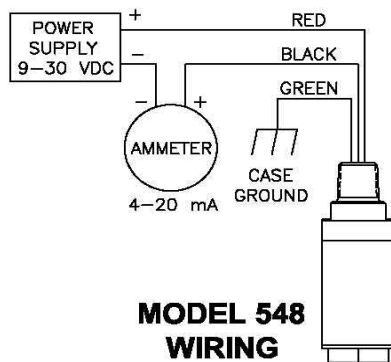

MODEL 548 WIRING

Red: + Power / + Signal
Black: - Power / - Signal
Green: Case Ground

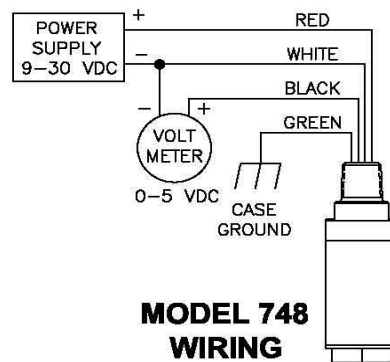

MODEL 748 WIRING

Red: + Power
White: - Signal / - Power
Black: + Signal
Green: Case Ground

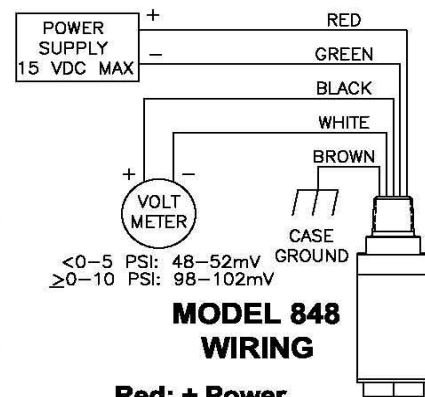

MODEL 848 WIRING

Red: + Power
Green: - Power
Black: + Signal
White: - Signal
Brown: Case Ground

Note: If the unit is certified for hazardous locations as Intrinsically Safe, use the enclosed connection diagram. Only the pressure transmitter is considered to have the Factory Mutual, CSA or ATEX safety ratings. If you have purchased a transmitter and isolator/remote seal, they have not been tested as a system for safety certification. The end-user shall be responsible for verifying the system is safe and installed accordingly.

OPTIONAL APPROVALS MODEL 548

548_NG_



Ex db IIC T6...T4 Gb
T6...T4: -20°C<Ta<80°C

PRESAFE 16 ATEX 8250X



548_NZ_(A)

[All product except as noted in labels 548NZ(B-C)]



APPROVED
NONINCENDIVE FOR USE IN
CL I, II & III, DIV. 2,
GRPS A,B,C,D,F,G
CL I, ZN 2, GP IIC
T4, Ta=80°C, T5, Ta=40°C
NEMA/TYP E 4X, HAZ LOC
DUAL SEAL
for Process Temps -40°F to 300°F

548_NZ_(B)

[G' Gage format, TH, TB, ZU]



APPROVED
NONINCENDIVE FOR USE IN
CL I, DIV. 2, GRPS A,B,C,D
CL I, ZN 2, GP IIC
T4, Ta=80°C, T5, Ta=40°C HAZ LOC
DUAL SEAL
for Process Temps -40°F to 300°F

548_NZ_(C)

[All product <300 PSIA/S/V]



APPROVED
NONINCENDIVE FOR USE IN
CL I, II & III, DIV. 2,
GRPS A,B,C,D,F,G
CL I, ZN 2, GP IIC
T4, Ta=80°C, T5, Ta=40°C
NEMA/TYP E 4X, HAZ LOC



METROLOGY CERT:
OC.C.30C001.A No 73774

548_TJ_(A)

[All product except as noted in 548_TJ_(B)]



CSA 04 1507558
CLASS I, DIV. 2,
GRPS A,B,C,D;
CLASS II, DIV. 2,
GRPS F,G;
CLASS III, DIV. 2
T5 at Ta=80°C
Type 4 Encl.
Dual Seal



[TJ & NX Maximum Pressure 5,000 psi]
548_TJ_(B)

[G, V format, ZU or TH option]



CSA 04 1507558
CLASS I, DIV. 2,
GRPS A,B,C,D;
T5 at Ta=80°C



548_NX_(A)

[All product except as noted in label 548_NX_(B)]



CLASS I, DIV. 1,
GRPS A,B,C,D;
CLASS II, DIV. 1, GRPS E,F,G;
CLASS III, DIV. 1
Ex Ia IIC T4, Ta=80°C,
T5, Ta=40°C
Type 4 Encl.
per drawing CD0646.
Dual Seal

548_NX_(B)

[G, V format, TH, or any all electrical connections]



CLASS I, DIV. 1,
GRPS A,B,C,D;
Ex Ia IIC T4, Ta=80°C,
T5, Ta=40°C
per drawing CD0646.

548_TF_(A)

[All product except as noted in labels 548TF(B-D)]



APPROVED
INT. SAFE FOR USE IN
CL I,II,III, DIV. 1, GRPS A,B,C,D,E,F,G
CL I, ZN 0, AEx Ia IIC T4, Ta=80°C,
T5, Ta=40°C NEMA/TYP E 4X, HAZ. LOC.
INSTALL PER CD0647
DUAL SEAL
for Process Temps -40°F to 300°F

548_TF_(B)

[G, V formats, TB option, ZU]



APPROVED
INT. SAFE FOR USE IN
CL I, DIV. 1, GRPS A,B,C,D,
CL I, ZN 0, AEx Ia IIC T4, Ta=80°C,
T5, Ta=40°C HAZ. LOC.
INSTALL PER CD0647
DUAL SEAL
for Process Temps -40°F to 300°F

548_TF_(C)

[All product <300 PSIA/S/V]



APPROVED
INT. SAFE FOR USE IN
CL I,II,III, DIV. 1, GRPS A,B,C,D,E,F,G
CL I, ZN 0, AEx Ia IIC T4, Ta=80°C,
T5, Ta=40°C NEMA/TYP E 4X, HAZ. LOC.
INSTALL PER CD0647
DUAL SEAL

548_TF_(D)

[TH, All alternate electrical connections except ZU]



APPROVED
INT. SAFE FOR USE IN
CL I, DIV. 1, GRPS A,B,C,D,
CL I, ZN 0, AEx Ia IIC T4, Ta=80°C,
T5, Ta=40°C HAZ. LOC.
INSTALL PER CD0647

548_NY_(A)

[All product ≥300 PSIA/S]



APPROVED
EXPLOSION PROOF FOR USE
IN CL I, DIV 1, GRPS A,B,C,D
CL I/II, DIV 1, GRPS E,F,G
CL I, ZN 1, AEx d IIC
T5 at Ta=80°C NEMA 4X
HAZ. LOC.
Factory Sealed,
Conduit Seal not Required
DUAL SEAL
for Process Temps -40°F to 300°F

548_NY_(B)

[All product (All Ranges) PSIG/PSIV/TB option]



APPROVED
EXPLOSION PROOF FOR USE
IN CL I, DIV 1, GRPS A,B,C,D
CL I/II, DIV 1, GRPS E,F,G
T5 at Ta=80°C NEMA 4X
HAZ. LOC.
Factory Sealed,
Conduit Seal not Required
DUAL SEAL
for Process Temps -40°F to 300°F

548_NY_(C)

[All product <300 PSIA/S]



APPROVED
EXPLOSION PROOF FOR USE
IN CL I, DIV 1, GRPS A,B,C,D
CL I/II, DIV 1, GRPS E,F,G
CL I, ZN 1, AEx d IIC
T5 at Ta=80°C NEMA 4X
HAZ. LOC.
Factory Sealed,
Conduit Seal not Required

548_TK_



Ex nA IIC T4 Gc
(-20°C<Ta<80°C)



PRESAFE 16 ATEX 8251X

548_NK_



Ex Ia IIC T4 Gc
(-20°C<Ta<80°C)
Ui=28V, Ii=100mA
Li=1.2μH, Ci=6nF
P<1W

PRESAFE 16 ATEX 8249X



548_DE_NK_



Ex Ia IIC T4 Gc
(-20°C<Ta<80°C)
Ui=28V, Ii=100mA
Li=1.5μH, Ci=9nF
P<1W

PRESAFE 16 ATEX 8249X



548_NK_ZU_



Ex Ia IIC T4 Gc
(-20°C<Ta<80°C)
Ui=28V, Ii=100mA
Li=69μH, Ci=17nF
P<1W

PRESAFE 16 ATEX 8249X



548_DE_NK_ZU_



Ex Ia IIC T4 Gc
(-20°C<Ta<80°C)
Ui=28V, Ii=100mA
Li=69μH, Ci=20nF
P<1W

PRESAFE 16 ATEX 8249X



OPTIONAL APPROVALS MODEL 748

748_TF_(A)

[All product except as noted in labels 748TF(B-D)]



APPROVED
INTRINSICALLY SAFE FOR USE IN CLASS I, II, III, DIV. 1, GROUPS A, B, C, D, E, F, G CLASS I, ZONE 0, AEx ia IIC T4, Ta=80°C, T5, Ta=40°C NEMA/TYPE 4X, HAZ. LOC. INSTALL PER CD0650 DUAL SEAL
for Process Temps -40°F to 300°F

748_TF_(B)

[G, V formats, TB, ZU]



APPROVED
INTRINSICALLY SAFE FOR USE IN CLASS I, DIV. 1, GROUPS A, B, C, D, CLASS I, ZONE 0, AEx ia IIC T4, Ta=80°C, T5, Ta=40°C HAZARDOUS LOCATIONS INSTALL PER CD0650 DUAL SEAL
for Process Temps -40°F to 300°F

748_TF_(C)

[All product ≤299 PSIA/S/V]



APPROVED
INTRINSICALLY SAFE FOR USE IN CLASS I, II, III, DIV. 1, GROUPS A, B, C, D, E, F, G CLASS I, ZONE 0, AEx ia IIC T4, Ta=80°C, T5, Ta=40°C NEMA/TYPE 4X, HAZ. LOC. INSTALL PER CD0650

748_TF_(D)

[TH, All alternate electrical connections except ZU]



APPROVED
INTRINSICALLY SAFE FOR USE IN CLASS I, DIV. 1, GROUPS A, B, C, D, CLASS I, ZONE 0, AEx ia IIC T4, Ta=80°C, T5, Ta=40°C HAZARDOUS LOCATIONS INSTALL PER CD0650

748_NZ_(A)

[All product except as noted in labels 748NZ(B-C)]



APPROVED
NONINCENDIVE FOR USE IN CL I, II & III, DIV 2, GPS A,B,C,D,F,G CL I, ZN 2, GP IIC T4, Ta=80°C, T5, Ta=40°C NEMA/TYPE 4X, HAZ. LOC. DUAL SEAL
for Process Temps -40°F to 300°F

748_NZ_(B)

[G Gage format, TH, TB, ZU]



APPROVED
NONINCENDIVE FOR USE IN CL I, DIV 2, GPS A,B,C,D CL I, ZN 2, GP IIC T4, Ta=80°C, T5, Ta=40°C HAZ. LOC. DUAL SEAL
for Process Temps -40°F to 300°F

748_NZ_(C)

[All product ≤299 PSIA/S/V]



APPROVED
NONINCENDIVE FOR USE IN CL I, II & III, DIV 2, GPS A,B,C,D,F,G CL I, ZN 2, GP IIC T4, Ta=80°C, T5, Ta=40°C NEMA/TYPE 4X, HAZ. LOC.

748_NZ_(D)

[All Alt. Connectors]



APPROVED
NONINCENDIVE FOR USE IN CL I, DIV 2, GPS A,B,C,D, T4, Ta=80°C, T5, Ta=40°C HAZ. LOC. WARNING: DO NOT DISCONNECT THE CONNECTOR WHILE THE CIRCUIT IS LIVE WHEN A FLAMMABLE OR COMBUSTIBLE ATMOSPHERE IS PRESENT.

748_TK_



Ex nA IIC T4 Gc (-20°C<Ta<80°C)
PRESAFE 16 ATEX 8251X



748_NY_(A)

[All product ≥300 PSIS/A]



APPROVED
EXPLOSION PROOF FOR USE IN CL I, DIV 1, GPS A,B,C,D CL II/III, DIV 1, GPS E,F,G CL I, ZN 1, AEx d IIC T5 at Ta=88°C NEMA 4X HAZ. LOC. Factory Sealed, Conduit Seal not Required DUAL SEAL
for Process Temps -40°F to 300°F

748_NY_(B)

[All product (All Ranges) PSIG/PSIV/TB Option]



APPROVED
EXPLOSION PROOF FOR USE IN CL I, DIV 1, GPS A,B,C,D CL II/III, DIV 1, GPS E,F,G T5 at Ta=88°C NEMA 4X HAZ. LOC. Factory Sealed, Conduit Seal not Required DUAL SEAL
for Process Temps -40°F to 300°F

748_NY_(C)

[All product <300 PSIS/A]



APPROVED
EXPLOSION PROOF FOR USE IN CL I, DIV 1, GPS A,B,C,D CL II/III, DIV 1, GPS E,F,G CL I, ZN 1, AEx d IIC T5 at Ta=88°C NEMA 4X HAZ. LOC. Factory Sealed, Conduit Seal not Required

748_NG_



Ex db IIC T8...T4 Gb (-20°C<Ta<60°C)
PRESAFE 16 ATEX 8250X



748_FA_



METROLOGY CERT:
OC.C.30C001.A No 73774

748_NK_



Ex ia IIC T4 Gc (-20°C<Ta<80°C)
Ui=28V, Ii=100mA
Li=1.8µH, Ci=9nF
Pi≤1W

PRESAFE 16 ATEX 8249X



748_DE_NK_



Ex ia IIC T4 Gc (-20°C<Ta<80°C)
Ui=28V, Ii=100mA
Li=2.4µH, Ci=12nF
Pi≤1W

PRESAFE 16 ATEX 8249X



748_NK_ZU_



Ex ia IIC T4 Gc (-20°C<Ta<80°C)
Ui=28V, Ii=100mA
Li=89µH, Ci=20nF
Pi≤1W

PRESAFE 16 ATEX 8249X



748_DE_NK_ZU_



Ex ia IIC T4 Gc (-20°C<Ta<80°C)
Ui=28V, Ii=100mA
Li=70µH, Ci=23nF
Pi≤1W

PRESAFE 16 ATEX 8249X



[TJ & NX Maximum Pressure 5,000 PSI]

748_NX_(A)

[All product except as noted in label 748_NX_(B)]



CSA 04 1507558
CLASS I, DIV 1, GRPS A,B,C,D;
CLASS II, DIV 1, GRPS E,F,G;
CLASS III, DIV 1,
Ex ia IIC T4, Ta=80°C,
T5, Ta=40°C
Type 4 Encl.
per drawing CD0649.
Dual Seal

748_NX_(B)

[G, V formats, TH, or any alt. electrical connections]



CSA 04 1507558
CLASS I, DIV. 1,
GRPS A,B,C,D;
Ex ia IIC T4, Ta=80°C,
T5, Ta=40°C
per drawing CD0649.

748_TJ_(A)

[All product except as noted in 748_TJ_(B)]



CSA 04 1507558
CLASS I, DIV. 2,
GRPS A,B,C,D;
CLASS II, DIV. 2,
GRPS F,G;
CLASS III, DIV. 2
T5 at Ta=80°C
Type 4 Encl.
Dual Seal



748_TJ_(B)

[G & alt. connectors]



CSA 04 1507558
CLASS I, DIV. 2,
GRPS A,B,C,D;
T5 at Ta=80°C



OPTIONAL APPROVALS MODEL 848

848_NG



Ex db IIC T6...T4 Gb
T6...T4: -20°C<Ta<80°C
PRESAFE 16 ATEX 8250X



848_NX_



Ex ia IIC T4 Ga
(-20°C<Ta<80°C)
Ui=28V, Ii=100mA
Li=2.4µH, Ci=12nF
Pi≤1W

PRESAFE 16 ATEX 8249X



848_NK_ZU_



Ex ia IIC T4 Ga
(-20°C<Ta<80°C)
Ui=28V, Ii=100mA
Li=70µH, Ci=23nF
Pi≤1W

PRESAFE 16 ATEX 8249X



848_TK_



Ex nA IIC T4 Gc
(-20°C<Ta<80°C)
PRESAFE 16 ATEX 8251X



[TJ & NX Maximum Pressure 5,000 PSI]

848_NX_(A)

[All product except as noted in label 848_NX_(B)]



CSA 04 1507558
CLASS I, DIV 1,
GRPS A,B,C,D;
CLASS II, DIV 1, GRPS E,F,G;
CLASS III, DIV 1,
Ex ia IIC T4, Ta=80°C,
T5, Ta=40°C
Type 4 Encl.
per drawing CD0646.
Dual Seal

848_NX_(B)

[G, V formats, TH, or any alt. electrical connections]



CSA 04 1507558
CLASS I, DIV. 1,
GRPS A,B,C,D;
Ex ia IIC T4, Ta=80°C,
T5, Ta=40°C
per drawing CD0646.

848_TJ_(A)

[All product except as noted in 848_TJ_(B)]



CSA 1507558
CLASS I, DIV. 2,
GRPS A,B,C,D;
CLASS II, DIV. 2,
GRPS F,G;
CLASS III, DIV. 2
T5 at Ta=80°C
Type 4 Encl.
Dual Seal



848_TJ_(B)

[G, V formats or alt. electrical connectors]



CSA 1507558
CLASS I, DIV. 2,
GRPS A,B,C,D;
T5 at Ta=80°C



848_NY_(A)

[All product ≥300 PSIS/A]



APPROVED
EXPLOSION PROOF FOR USE
IN CLASS I, DIV. 1, GROUPS A,B,C,D
CLASS II/III, DIV. 1, GROUPS E,F,G
CLASS I, ZONE 1, AEx d IIC
T5 at Ta=88°C NEMA 4X
HAZARDOUS LOCATIONS
Factory Sealed,
Conduit Seal not Required
DUAL SEAL
for Process Temps -40°F to 300°F

848_NY_(B)

[All product (All Ranges) PSIG/PSIV/TB Option]



APPROVED
EXPLOSION PROOF FOR USE
IN CLASS I, DIV. 1, GROUPS A,B,C,D
CLASS II/III, DIV. 1, GROUPS E,F,G
T5 at Ta=88°C NEMA 4X
HAZARDOUS LOCATIONS
Factory Sealed,
Conduit Seal not Required
DUAL SEAL
for Process Temps -40°F to 300°F

848_NY_(C)

[All product <300 PSIS/A]



APPROVED
EXPLOSION PROOF FOR USE
IN CLASS I, DIV. 1, GROUPS A,B,C,D
CLASS II/III, DIV. 1, GROUPS E,F,G
CLASS I, ZONE 1, AEx d IIC
T5 at Ta=88°C NEMA 4X
HAZARDOUS LOCATIONS
Factory Sealed,
Conduit Seal not Required

848_NZ_(A)

[All product except as noted in labels 848NZ(B-C)]



APPROVED
NONINCENDIVE FOR USE IN
CL I, II & III, DIV. 2,
GPS A,B,C,D,F,G
CL I, ZN 2, GP IIC
T4, Ta=80°C, T5, Ta=40°C
NEMA/TYP 4X, HAZ LOC
DUAL SEAL
for Process Temps -40°F to 300°F

848_NZ_(B)

['G' Gage format, TH, TB, ZU]



APPROVED
NONINCENDIVE FOR USE IN
CL I, DIV. 2, GPS A,B,C,D
CL I, ZN 2, GP IIC
T4, Ta=80°C, T5, Ta=40°C HAZ LOC
DUAL SEAL
for Process Temps -40°F to 300°F

848_NZ_(C)

[All product ≤299 PSIA/S/V]



APPROVED
NONINCENDIVE FOR USE IN
CL I, II & III, DIV. 2,
GPS A,B,C,D,F,G
CL I, ZN 2, GP IIC
T4, Ta=80°C, T5, Ta=40°C
NEMA/TYP 4X, HAZ LOC

848_FA_



METROLOGY CERT:
OC.C.30C001.A No 73774

848_TF_(A)

[All product except as noted in labels 848TF(B-D)]



APPROVED
INTRINSICALLY SAFE FOR USE IN
CL I,II,III, DIV. 1, GPS A,B,C,D,E,F,G
CL I, ZN 0, AEx ia IIC T4, Ta=80°C,
T5, Ta=40°C NEMA/TYP 4X, HAZ. LOC.
INSTALL PER CD0647
DUAL SEAL
for Process Temps -40°F to 300°F

848_TF_(B)

[G, V formats, TB, ZU]



APPROVED
INTRINSICALLY SAFE FOR USE IN
CL I, DIV. 1, GPS A,B,C,D,
CL I, ZN 0, AEx ia IIC T4, Ta=80°C,
T5, Ta=40°C HAZ. LOC.
INSTALL PER CD0647
DUAL SEAL
for Process Temps -40°F to 300°F

848_TF_(C)

[All product ≤299 PSIA/S/V]



APPROVED
INTRINSICALLY SAFE FOR USE IN
CL I,II,III, DIV. 1, GPS A,B,C,D,E,F,G
CL I, ZN 0, AEx ia IIC T4, Ta=80°C,
T5, Ta=40°C NEMA/TYP 4X, HAZ. LOC.
INSTALL PER CD0647

848_TF_(D)

[TH, All alternate electrical connections except ZU]



APPROVED
INTRINSICALLY SAFE FOR USE IN
CL I, DIV. 1, GPS A,B,C,D,
CL I, ZN 0, AEx ia IIC T4, Ta=80°C,
T5, Ta=40°C HAZ. LOC.
INSTALL PER CD0647

MECHANICAL INSTALLATION

The X48 series requires no special mounting equipment. The unit may be mounted directly to the process fitting in any orientation with negligible positioning error. For standard NPT pressure fittings it is recommended that Teflon tape or an equivalent sealant be applied to the threads before installation. It is recommended that all NPT fittings be torque to 50 ft/lbs.

ELECTRICAL CONNECTIONS

The standard wiring of your Viatran pressure transmitter is outlined on page 3. If your unit was ordered with an alternate connector or special wiring refer to the wiring marking permanently marked on your unit. The X48 series transmitters can be powered by a dc power supply ranging from 9 to 30 volts. If you have a 4-20 mA (548) device please refer to the load/voltage chart (below) to identify the required input voltage for your specific system load. The recommended load impedance for the model 748 is 50k ohms minimum.

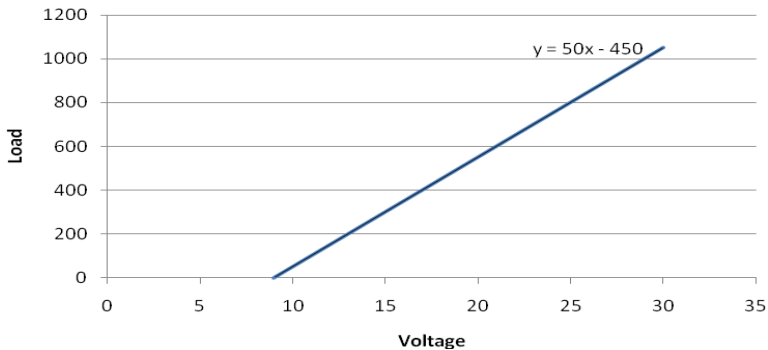

MAINTENANCE AND REPAIR

All Viatran transmitters have been designed to function free from routine or scheduled maintenance. Simple cleaning of the pressure cavity on an as needed basis will provide many years of satisfactory performance. Protecting the product from continued exposure to moisture or fluids at the electrical connection, breather area will eliminate premature internal failure of the product. Generally any time the product is removed from service, the pressure cavity should be flushed with a stainless steel compatible cleaner to prevent media buildup. During the cleaning process only a soft, lint-free cloth is recommended. Never use a coarse or stiff bristle brush to clean media from the diaphragm surface.

It is suggested that the calibration be verified on a usage dependent schedule. If the product is in continuous service 7 days a week, then calibration verification may be necessary every 6 to 8 months. If the product is in a lab test environment, a more lenient verification schedule would be appropriate. In all instances the performance of the product will depend on the individual application or process in which it is installed. More continued usage would require a shorter period between calibration verification and product maintenance.

If a product is perceived to be exhibiting problems, it can be returned to Viatran for analysis and/or repair. It is suggested that only Viatran personnel attempt repair of the product. Any damage resulting from customer disassembly would result in a loss of coverage under the warranty policy. Older products returned for repair are updated to current specifications unless the repair cost would outweigh the cost of a new replacement model. Products returned for repair should include information on the person to contact for repair quote approval, the individual to contact if Viatran's technical staff requires additional information during analysis, and a brief description of the problem associated with the product's failure.

REPAIR INSTRUCTIONS

Viatran's Transmitters are designed to be easily repaired and recalibrated if necessary. If a failure occurs, the transmitter should be returned to the factory for inspection and testing. Please contact the Customer Support Department at 1-800-688-0030, for a return tracking number and/or a repair cost estimate. A nominal inspection fee is charged on all units returned to the factory which are not subsequently repaired.

WARRANTY

Viatran Corporation warrants that its products shall be free from defective workmanship and/or material for a period of twelve (12) months from the date of shipment, provided that Viatran's obligation hereunder shall be limited to correcting any defective workmanship and/or replacing any defective material f.o.b. factory. No allowance will be made for any expense incurred for correcting any defective workmanship and/or material without written consent by Viatran. This warranty is in lieu of all other warranties expressed or implied.